



SERVICE BULLETIN

SB1244

ADDRESSEES	: Owners and operators of coaches listed under 'Application'
VEHICLE MODEL	: C2045, T2145
SYSTEM/SUBSYSTEM	: Traction engine - Cooling system
BULLETIN TYPE	: Service Information
DATE	: May 3, 2011
SUBJECT	: Cooling system evaluation and corrective measures
TERMS & CONDITIONS	: This document does not entitle to any reimbursement.

APPLICATION:

Model	Engine	Transmission	VIN
C2045	Caterpillar C13 KCB	ZF AS Tronic or Allison B500	47001 → 47527
T2145			44801 → 44855

DESCRIPTION:

- As a result of frequent engine failures soon after work had been performed on the engine cooling and interior heating circuit, Caterpillar has conducted extensive tests to determine if the cooling system capacity of the above-mentioned units is within Caterpillar's requirements, and to find the root cause of the engine failures on C13 KCB engines.
- The test results have revealed the following:
 - The engine cooling capacity is within Caterpillar's requirements.
 - The minimum coolant level sensor prescribed by Caterpillar has been proven to be not always reliable, and has proven to require regular cleaning.
 - The flow to the expansion tank is high, but the de-aeration of the tank is within Caterpillar's requirements.
- In an effort to make the cooling system more robust when operating under low coolant scenarios and to further emphasize the necessity to properly fill the cooling system, Van Hool releases through this Bulletin the following C13 KCB service improvement recommendations:
 - The transmission cooler bleed line should be retrofitted with a 3/32" restrictor to reduce the flow rate through the expansion tank (Figure1).
 - Cleaning of the sensor should be part of the Maintenance Schedule (12,000 mile interval).
 - It is important to maintain an expansion tank in the upper range of the min/max marks at all times.
 - It is recommended to clean the charge air cooler (CAC) and radiator at half the intervals noted in the Maintenance Manual (was 24,000 miles).
The special cleaning tool that has been developed for this purpose is #10527208.

- A “new” decal is to be added to the expansion tank detailing the necessity to fill the engine cooling and interior heating circuits properly.

This decal should be placed over the existing #11109825 decal (Figure 2) that was released with SB1220.

In addition to the information listed, the new decal will make reference to a second decal to be added to the inside of the auxiliary heater compartment door.

The second decal lists a complete manual fill procedure encompassing all coaches, regardless of the production year.

This is the information a technician (unfamiliar with the coach) working on the side of the road needs in order to perform the job correctly.

Examples of each decal are listed in attachments 1 and 2 of this Service Bulletin.

4. Please refer to the procedure in this Service Bulletin to retrofit a 3/32” restrictor into the transmission cooler bleed line, and to become acquainted with the manual fill procedure for the engine cooling and interior heating circuit.

MATERIAL:

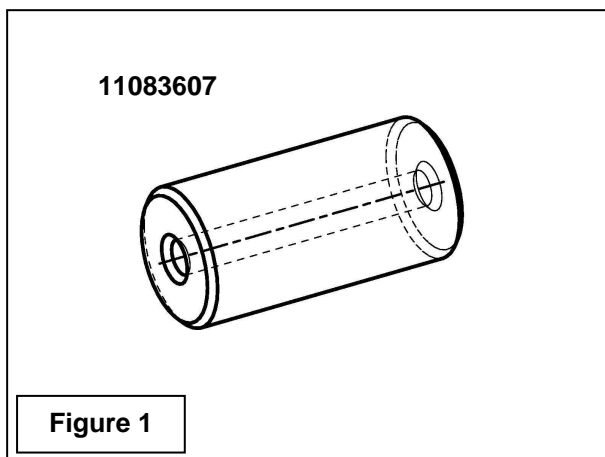

Figure 1

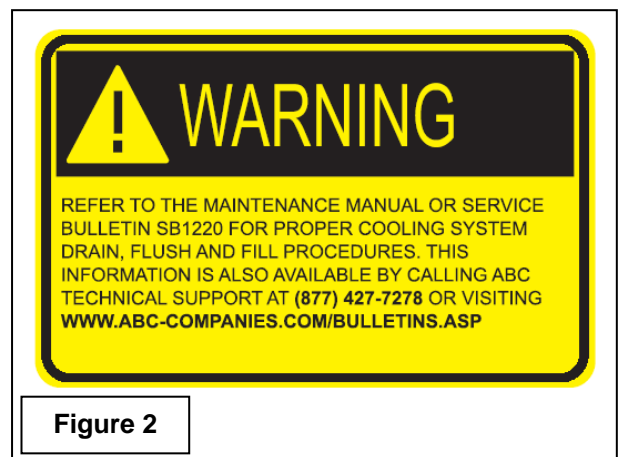

Figure 2

Current material

VH reference	Description	Qty.	Refer to
11109825	Decal, “Warning! Refer to MM or SB1220...”	1	Figure 2

New material

VH reference	Description	Qty.	Refer to
ABC-12712	Decal, “This coach requires a specific...”, 1 of 2	1	Attachment 1
ABC-12759	Decal, “Warning! This coach requires a specific...”	1	Attachment 1
ABC-12713	Decal, “This coach requires a specific...”, 2 of 2	1	Attachment 2
11083607	Restrictor, OD 10 mm, ID 3/32”, L 25/32”	1	Figure 1

- Material may be obtained through regular channels.
- Parts/Waste disposal: discard old material according to applicable environmental regulations.

Continued on next page.

PROCEDURE:

1. Important notes:

The information below is repeated on decal 1 of 2.

***NOTE:** With the coolant drained from the expansion tank, disconnect and remove the coolant level sensor from the center of the tank on the forward facing side. Wipe the sensor clean and reinstall.*

***NOTE:** The fill rate must not exceed 2 gallons per minute. Unless the manual heating circuit valves were closed during system draining, you must assume the heating circuit will require filling. This process takes 1 to 2 hours to perform. Service Bulletin SB1220 details the required fill procedure. SB1220 is available at www.abc-companies.com/bulletins.asp OR call (877) 427-7278*

***NOTE:** There are 3 heating circuit solenoid valves located midway on the left hand side behind the auxiliary heater. Each valve is open with the ignition off. As soon as the ignition is turned on, the valves may close depending on the HVAC system status. To completely fill the engine and heating circuits, a process must be carried out to open the valves and operate the electric boost pump (coolant circulation pump M126).*

***NOTE:** If you do not have the expertise to perform present procedure, do not hesitate to go to your nearest ABC Customer Care & Parts Source service center.*

2. General:

- This job has to be carried out by a technician proficient in cooling system service.
- For more information refer to the service literature that comes with the vehicle.

3. Special tools, equipment or services:

- This job does not require special tools, equipment nor services.

4. Preparations:

- Park the coach on a level-surfaced service pit with the front wheels straight. When using portable post lifts instead of a service pit, lower the suspension first. Apply the parking brake and shut down the engine.
- Switch off all systems and turn off the battery master switch.

Make sure the passenger compartment climate control system is switched off  and the

driver's cab temperature control  is set to zero.

- Install a "DO NOT OPERATE" warning message on the instrument panel.
- Read the entire procedure before beginning to work.

CAUTION: When working in the engine compartment, turn the starter motor inhibitor switch to "starter motor disabled" for the steps, which do not require engine operation.

CAUTION: To avoid personal injury, make sure components and fluids have cooled down sufficiently before starting work on the engine cooling and interior heating circuit.

CAUTION: Observe safe shop practices at all times.

5. **To install transmission cooler bleed line restrictor #11083607:**

- 1) Drain coolant from the expansion tank to below the level of the transmission cooler bleed line take-off, the engine bleed line take-off, and the filler bleed line take-off (Figure 3a).
- 2) At the expansion tank, slacken the hose clamp securing the transmission cooler bleed line. Detach the hose from the take-off. Insert restrictor 11083607 into the bleed line until it is flush with the hose. Reattach the hose to the take-off. Tighten the hose clamp. Mark the hose with green tape where it connects to the expansion tank to indicate that a restrictor has been fitted.
- 3) Top up the tank with coolant as described in the Maintenance Manual, Chapter 3.24 "To check coolant level".

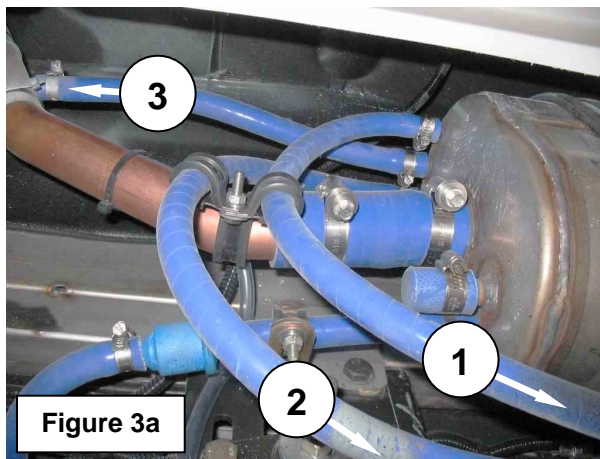

Figure 3a: Bleed lines at the expansion tank

1. To transmission cooler
2. To engine
3. To filler neck

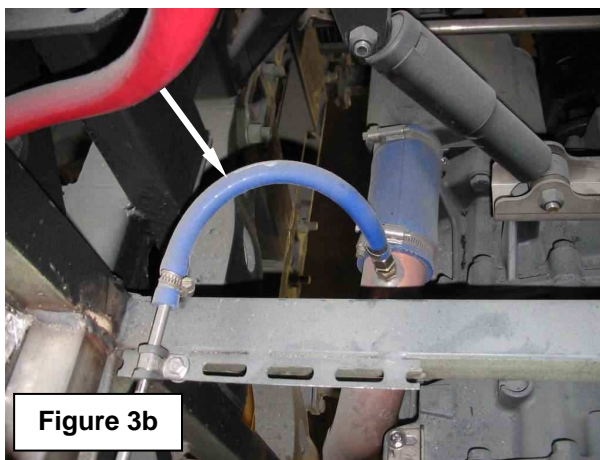

Figure 3b: Transmission cooler bleed line downstream installation

4. **To fill and bleed the engine cooling and interior heating circuit:**

NOTE: This procedure is repeated on decal 2 of 2. The 1st decal is located on the expansion tank in the engine compartment.

NOTE: SB1220 details the proper sequence to open the valves and turn on the pump. However, if you are unable to obtain a copy of SB1220, the valves can be manually opened by removing the valve solenoids (Figure 4).

The pump can be engaged by connecting a jumper between the auxiliary heater power connector (red and brown cable) and the pump connector (red and black cable).

These connectors are located at the bottom of the auxiliary heater (Figure 5).

The manual procedure is detailed below.

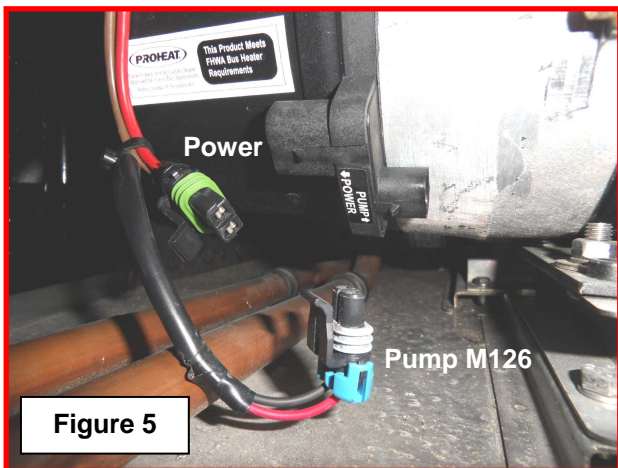
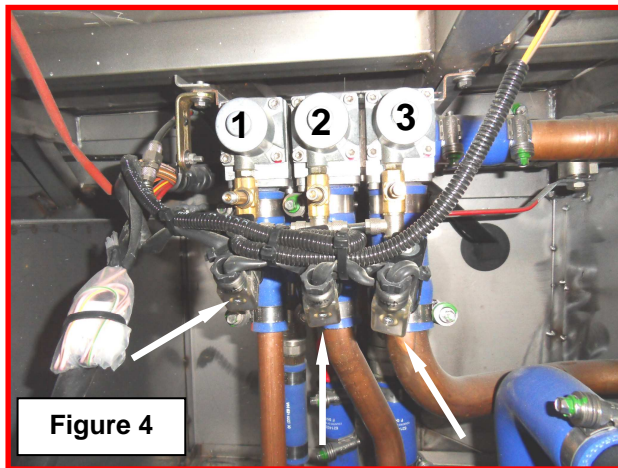

CAUTION: When carrying out this procedure in a confined space, connect the engine and auxiliary heater exhaust to an appropriate exhaust fume evacuating system.

CAUTION: Failure to properly fill the engine and heating circuit may result in severe engine damage!

CAUTION: If required, top up expansion tank with coolant after each step.

- 1) Fill the engine circuit at a rate not exceeding 2 gallons per minute. If the system is filled at a rate faster than this, air can be trapped. Once the coolant in the expansion tank is at the top of the minimum mark, wait 15 minutes to ensure the level does not drop.
- 2) Once stable, open the heating circuit valves by removing the valve solenoids and engage the boost pump, Figures 4 and 5. Allow the boost pump to run for 5 minutes.
- 3) Turn off the boost pump and reinstall the solenoids to the valves (Figures 4 and 5).
- 4) Start the engine and set idle at 900 rpm for ~5 minutes.
Top up with coolant as the level in the expansion tank drops.
- 5) Turn on the boost pump.
- 6) Remove the solenoid of the left-hand valve for the floor heaters (1, Figure 4).
Let the floor heater circuit purge until you can no longer hear air gurgling ~5 minutes.
Top up with coolant as required.
Reinstall the left-hand valve solenoid.

- 7) Remove the solenoid of the center valve for the driver's heater (2, Figure 4).
Let the driver's heater circuit purge until you can no longer hear air gurgling for ~5 minutes.
Top up with coolant as required.
Reinstall the center valve solenoid.
- 8) Remove the solenoid of the right-hand valve for the roof heater circuit (3, Figure 4).
Let the roof heater circuit purge until you can no longer hear air gurgling for ~5 minutes.
Top up with coolant as required. Leave the solenoid detached.
- 9) Remove the solenoids of the left-hand and center valves (1 and 2, Figure 4).
- 10) Reconnect the plugs to the auxiliary heater.
- 11) Ensure the expansion tank level is at the top of the maximum mark and install the filler cap.
- 12) Start the engine, turn on the auxiliary heater (press down on the  button) and drive the coach until the engine has reached normal operating temperature.
- 13) Ensure heat is being delivered to each of the three heating circuits.
Engage the driver's fan and main cabin fans to perform this check.
The floor radiators should feel warm to the touch.
If any heating circuit delivers less heat than normal, purge that circuit again.
- 14) Reinstall the heating circuit valve solenoids and turn off the boost pump.
- 15) Stop the engine and check the coolant level as soon as the system has cooled down completely. Top off the expansion tank to the top of the maximum mark.

Procedure complete.

ATTACHMENTS:

Attachment 1: "This coach requires a specific coolant fill procedure" (Decal 1 of 2)

Attachment 1: "Warning! This coach requires a specific coolant fill procedure"

Attachment 2: "This coach requires a specific coolant fill procedure" (Decal 2 of 2)

DISCLAIMER:

The procedures contained herein are not exclusive. Van Hool cannot possibly know, evaluate, or advise the transportation industry of all conceivable ways in which a procedure may be undertaken or of the possible consequences of each such procedure. Other procedures may be as good, or better, depending upon the particular circumstances involved.

Each carrier who uses the procedures herein must first satisfy itself thoroughly that neither the safety of its employees or agents, nor the safety or usefulness of any products, will be jeopardized by any procedure selected.

INFORMATION HANDLING:

Important supplements to and modifications of the technical information not yet included in the Van Hool manuals are communicated by means of Service Bulletins.

File the Service Bulletins at the back of your manual, in numerical order.

To make sure that you will be reminded of the Bulletins that have appeared in the meantime while paging the manual, mark the pages concerned by hand with the Service Bulletin number.

ATTACHMENT 1

WARNING!!

**THIS COACH REQUIRES A SPECIFIC COOLANT FILL PROCEDURE
DECAL 1 of 2**

NOTE: With the coolant drained, remove the coolant level sensor from the center of the surge tank on the forward facing side. Wipe the sensor clean and reinstall. The fill rate must not exceed 2 gallons per minute. Unless the manual heating circuit valves were closed during system draining, you must assume the heating circuit will require filling. This process takes 1-2 hrs to perform. Service Bulletin SB1220 details the required fill procedure. SB1220 is available at

www.abc-companies.com/bulletins.asp OR call (877) 427-7278

There are 3 heating circuit solenoid valves located midway on the left hand side behind the auxiliary heater. Each valve is open with the ignition off. As soon as the ignition is turned on, the valves may close depending on the HVAC system status. To completely fill the engine and heating circuits, a process must be carried out to open the valves and operate the electric boost pump.

This is decal 1 of 2. The 2nd decal is located on the door to the auxiliary heater compartment. Please refer to the 2nd decal for further instruction.

Failure to properly fill the engine and heating circuit may result in severe engine damage!

ABC-12712

WARNING!!

**THIS COACH REQUIRES
A SPECIFIC
COOLANT FILL PROCEDURE**

ABC-12759

**REFER TO THE RADIATOR
SURGE TANK FOR
FURTHER INFORMATION**

**THIS COACH REQUIRES A SPECIFIC COOLANT FILL PROCEDURE
DECAL 2 of 2**

This is decal 2 of 2. The 1st decal is located on the expansion tank in the engine compartment. SB1220 details the proper sequence to open the valves and turn on the pump. However, if you are unable to obtain a copy of SB1220, the valves can be manually opened by removing the solenoids from the valve stems, Figure 1. The pump can be engaged by connecting a jumper between the auxiliary heater power plug and the pump plug. These plugs are located at the bottom of the auxiliary heater, Figure 2. The manual procedure is detailed below.

CAUTION! - Park the coach safely, apply the parking brake, stop the engine, switch off all systems. Install a “DO NOT OPERATE” message on the steering wheel. Turn the starter motor inhibit switch to “starter motor disabled”. Make sure all components have cooled down sufficiently prior to starting work. When carrying out this procedure in a confined space, connect the engine and auxiliary heater exhaust to an appropriate exhaust fume evacuating system. Observe safe shop practices at all times.

1. Fill the engine circuit at a rate not exceeding 2 gallons per minute. If the system is filled at a rate faster than this, air can be trapped. Once the coolant in the expansion tank is at the top of the min mark, wait 15 minutes to ensure the level does not drop.
2. Once stable, open the heating circuit valves by removing the solenoids and engage the boost pump, Figures 1 & 2. Allow the boost pump to run for 5 minutes.
3. Turn off the boost pump and reconnect the solenoids to the valves, Figures 1 & 2.
4. Start the engine and set high idle at 900 rpm for ~5 minutes. Top up with coolant as the level in the expansion tank drops.
5. Turn on the boost pump.
6. Remove the solenoid from the left valve for the floor heaters, Figure 1. Let the floor heater circuit purge until you can no longer hear air gurgling ~5 minutes. Top up with coolant as required. Reconnect the left valve solenoid.
7. Remove the solenoid from the center valve for the driver’s heater, Figure 1. Let the driver’s heater circuit purge until you can no longer hear air gurgling for ~5 minutes. Top up with coolant as required. Reconnect the center valve solenoid.
8. Remove the solenoid from the right valve for the roof heater circuit, Figure 1. Let the roof heater circuit purge until you can no longer hear air gurgling for ~5 minutes. Top up with coolant as required. Leave the solenoid disconnected.
9. Disconnect the solenoids from the left and center valves.
10. Reconnect the plugs to the auxiliary heater.
11. Ensure the expansion tank level is at the top of the max mark and install the radiator cap.
12. Start the engine, turn on the auxiliary heater (press down on the  button), and drive the coach until the engine has reached normal operating temperature.
13. Ensure heat is being delivered to each of the three heating circuits. Engage the driver’s fan and main cabin fans to perform this check. The floor radiators should feel warm to the touch. If any heating circuit is not delivering heat, purge that circuit again.
14. Reconnect the heating circuit valve solenoids. Stop the engine and check the coolant level as soon as the system has cooled down completely. Top off the expansion tank to the top of the max mark.



Figure 2



Figure 2

Failure to properly fill the engine and heating circuit may result in severe engine damage!

ABC-12713