



# SERVICE BULLETIN No.1133

Circulate to listed addressees

<b>COACH MODEL</b>	: C2045 and T2145
<b>BULLETIN TYPE</b>	: Product Improvement
<b>MANUAL &amp; SECTION</b>	: N/A
<b>PARTS BOOK REVISION</b>	: No
<b>DATE</b>	: May 4, 2004
<b>SUBJECT</b>	: <b>HVAC condenser installation</b>
<b>TERMS &amp; CONDITIONS</b>	: No claims will be accepted with reference to this Bulletin.

## APPLICATION:

The product improvement subject of this Bulletin has been cut into production as from following units:

Model	Engine	VIN
T2145	Cummins	44301 →
	Detroit Diesel	44618 →
C2045	Cummins	45427 → 45440, 45442 →
	Detroit Diesel	45899, 45905 → 45934, 45955 → 45999, 46501 →

## DESCRIPTION:

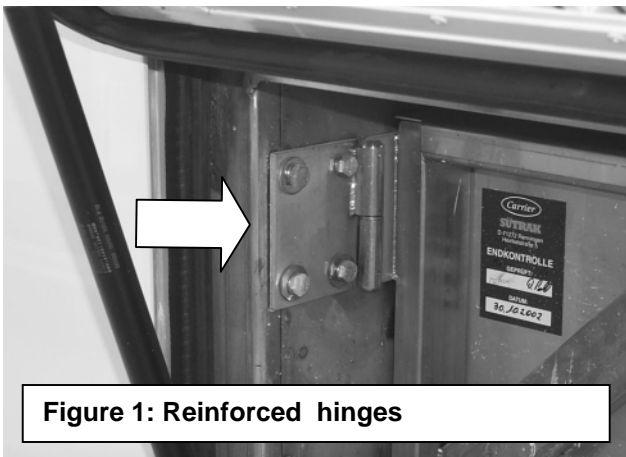
Detail design changes have been made to the condenser installation in order to improve the serviceability and reliability of the system.

Following items have been reviewed:

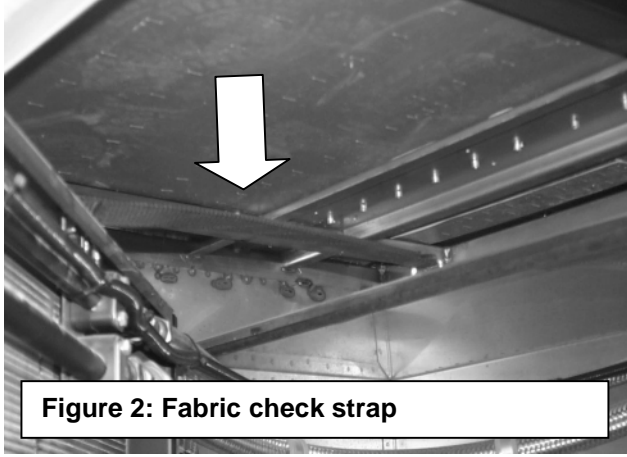
1. The condenser hinges have been reinforced (see Figure 1).
2. The chain, which restricts the condenser swing-out, has been replaced by a fabric check strap (see Figure 2).
3. The condenser top pull catch has been replaced by a springloaded latch (see Figures 3 and 4).
4. The bottom latch locks into a ramp, which positively supports the condenser when stowed (see Figure 5).
5. The condenser fan band-type support frames have been replaced by rod-type (see Figure 6).
6. An additional pull handle has been installed next to the dryer-receiver to facilitate condenser service (see Figure 7 and 8).

*Service personnel: please read, initial and circulate.*

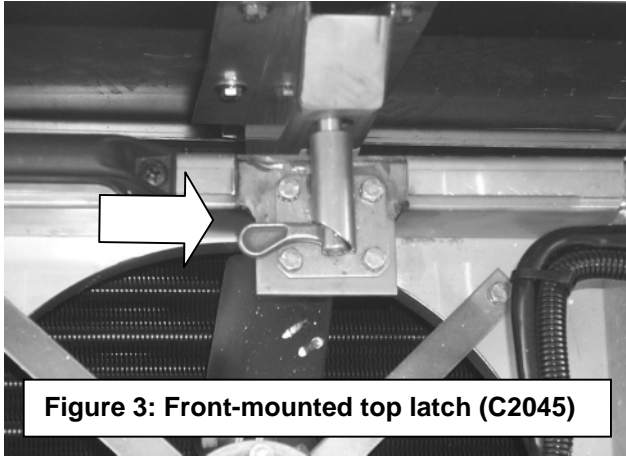
Service Manager	Parts Manager	Warranty Administrator	Workshop Foreman	Service Technician



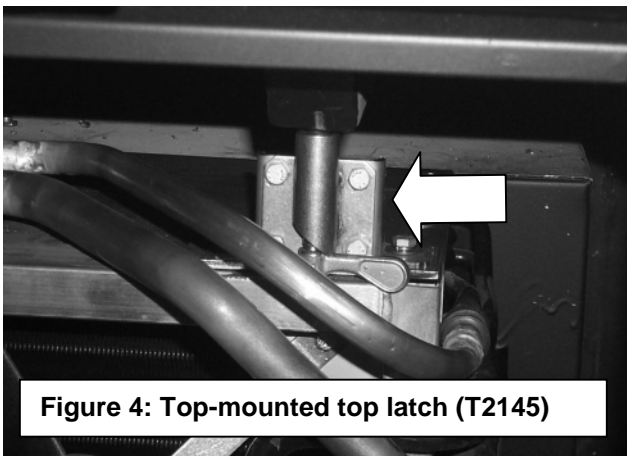
**Figure 1: Reinforced hinges**



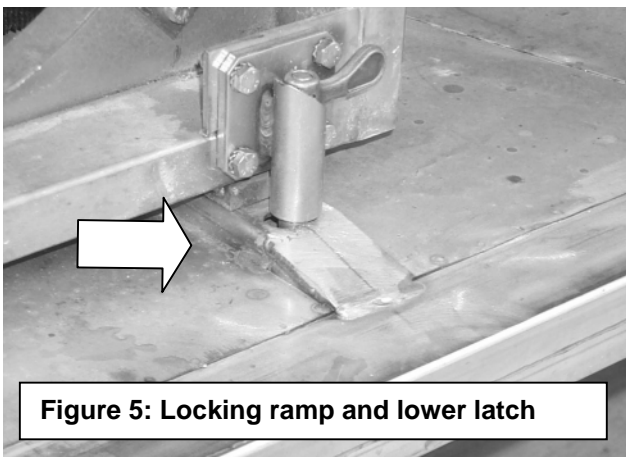
**Figure 2: Fabric check strap**



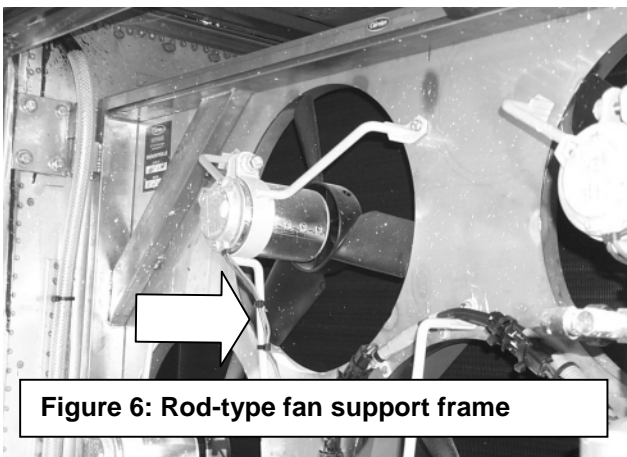
**Figure 3: Front-mounted top latch (C2045)**



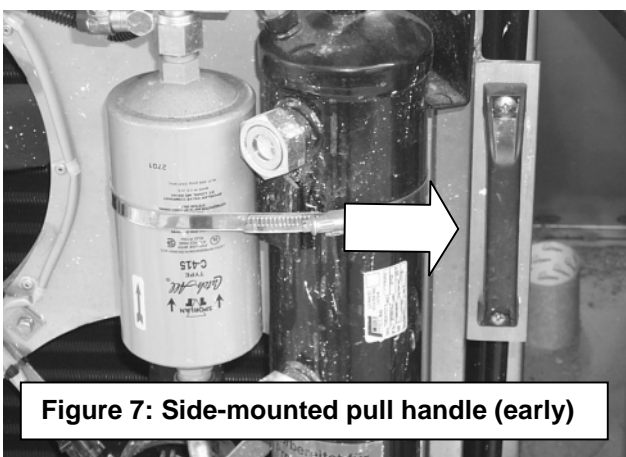
**Figure 4: Top-mounted top latch (T2145)**



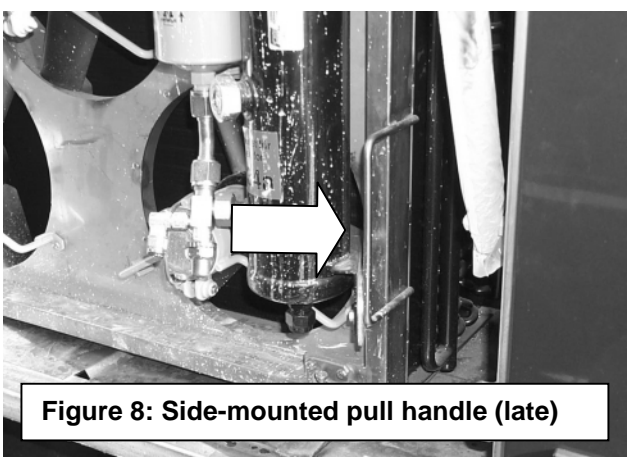
**Figure 5: Locking ramp and lower latch**



**Figure 6: Rod-type fan support frame**

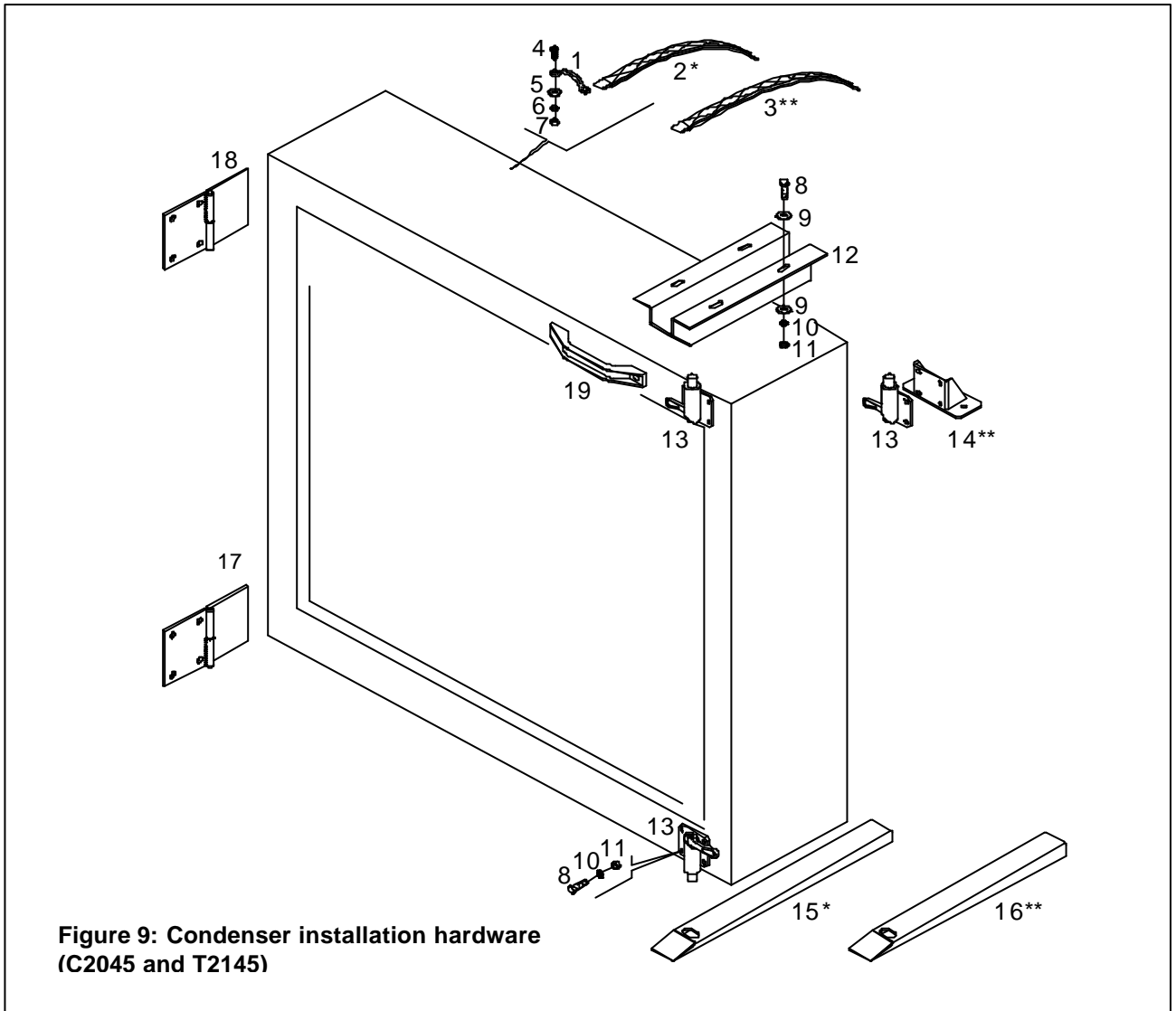


**Figure 7: Side-mounted pull handle (early)**



**Figure 8: Side-mounted pull handle (late)**

**PARTS AND PRODUCTS:**



**Figure 9: Condenser installation hardware (C2045 and T2145)**

Pos.	Part No.	Description	Qty.
1	VH 660349205	Eye	2
2*	VH 10859200	Strap	1
3**	VH 10790481	Strap	1
4	VH 10709241	Bolt	4
5	VH 660621505	Washer	4
6	VH 660636202	Spring washer	4
7	VH 660209936	Nut	4
8	VH 660229754	Bolt	12
9	VH 660623508	Washer	8
10	VH 660637605	Spring washer	12
11	VH 660209922	Nut	12
12	VH 91800761	Support channel	1
13	VH 10595346	Latch	2
14**	VH 91800848	Condenser top mounting bracket for latch VH10595346	1

*Parts continued on next page.*

Parts continued from page 1 of 2

Pos.	Part No.	Description	Qty.
15*	VH 91800762	Ramp	1
16**	VH 91800834	Ramp	1
17	VH 10893015	Hinge assembly, lower	1
18	VH 10893016	Hinge assembly, upper	1
19	VH 660174306	Handle	1

\* C2045 \*\* T2145

New parts will be made available through regular channels.

Parts may be purchased from your nearest ABC Customer Care & Parts Source dealership.

Parts and products disposition: discard according to applicable environmental regulations.